

AN ISO
9001 : 2008
COMPANY

Translate your dreams
into a **magical** reality

HARTTM
for life time steel

architectural
Hardware
FITTINGS

Delivering Versatile Elements of aesthetics

company Profile

ABOUT US:-

ALFA is leading manufacturer of corrosive resistance high grade AISI 316/304 stainless steel architectural hardware fitting since last many year. Products are manufacturing under the brand name **HART**.

The product range portfolio has a wide range of products offered by us are demanded in the market to their features, design, polish and finish, dimensional accuracy, durability.

Our products are used in worldwide in different projects such as Commercial, Industrial, Domestic and International.

Our organisation is backed by experienced team members. Who helps in understanding the diverse requirement of the client and offering the products accordingly.

INFRASTRUCTURE:-

In our company well equipped modern machinery like as a VMC, CNC, Hydraulic banding machine, Power press, Buffing machine, Cutting machine, Hydraulic press, Manual batch grinder, Lath machine, Thread machine, Drill, Surface batch grinding machine and Round pipe grinding machine, Tig welding machine etc. To produce a better & bulk production. Our total production are "in-house".

QUALITY & MANAGEMENT:-

All of our products are manufacture under one roof following ISO 9001:2008 quality standards.

We manufacture these products by using superior quality raw material which is sources from the reliable vendors. Raw materials are tested on different physical and chemical parameter to ensures their quality.

We having modern machinery to makes process of converting raw materials into finished goods.

During the process we better take care of the products to be its best when process ends. We giving equal importance production expansion as well as pre & post services.

MISSION:-

Our mission is to provide high quality products with reasonable rate, best customer service and the product guarantee. We are trying to provide satisfaction to our each and every customer and dispatch as per commitment.

METHODOLOGY:-

We believe in strong research and development before we launch our products in market. We also gets the valuable opinion from Architectures and Interior designers for better look comfort and style of our product.

VISION:-

Over the years, our company has introduced high quality and latest product range for society to leave the competitors for behind in order to meet the set goal of company. We use constant changing as per market demand and client specified requirements.

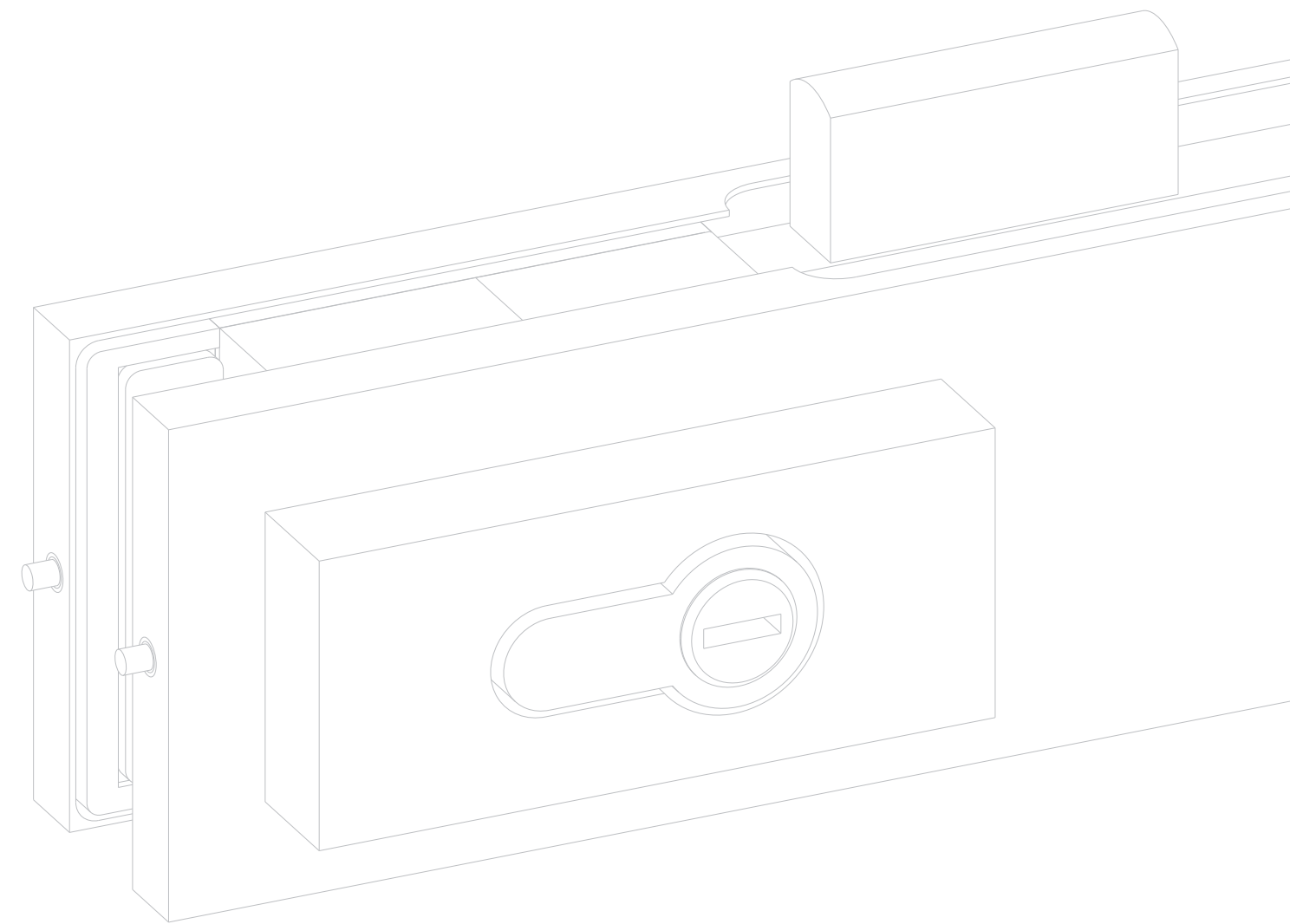

Making things smooth in the life and better usability is exact need cotteder by us.

PATCH FITTINGS

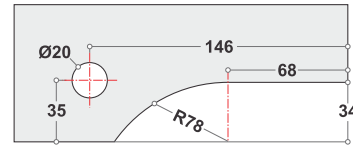

APF-01

Top patch
Finish : Satin
Material : Aluminium alloy body & stainless steel 304 grade cover plate

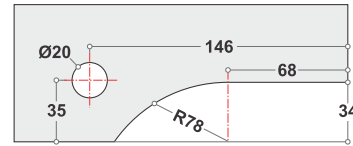

APF-02

Bottom patch
Finish : Satin
Material : Aluminium alloy body & stainless steel 304 grade cover plate

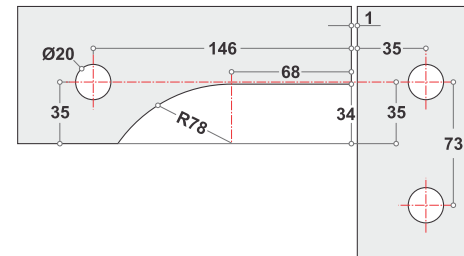

APF-03

Over panel side panel patch with pivot (Big "L")
Finish : Satin
Material : Aluminium alloy body & stainless steel 304 grade cover plate

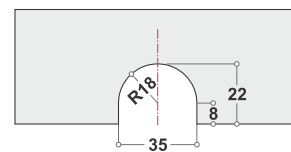

APF-04

Aluminium fixed floor
Finish : Satin
Material : Aluminium alloy body & stainless steel 304 grade cover plate

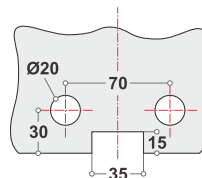

APF-05

Glass to glass aluminium fixed floor
Finish : Satin
Material : Aluminium alloy body & stainless steel 304 grade cover plate

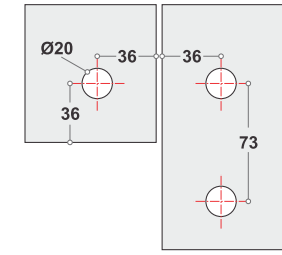

APF-06

Over panel side panel patch (Small "L")
Finish : Satin
Material : Aluminium alloy body & stainless steel 304 grade cover plate

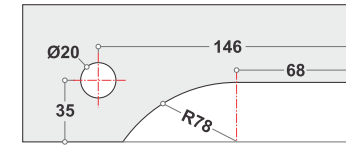

APF-07

Over panel patch with pivot & wall
Finish : Satin
Material : Aluminium alloy body & stainless steel 304 grade cover plate

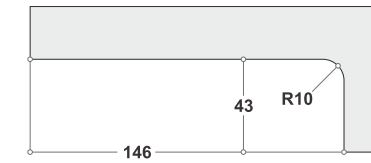

APF-08

Patch lock
Finish : Satin
Material : Aluminium alloy body & stainless steel 304 grade cover plate

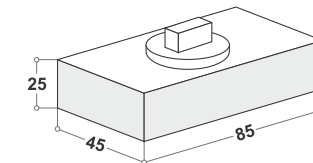

APF-09

Bottom bearing patch pivot
Finish : Satin
Material : Stainless steel 304 grade & M.S.

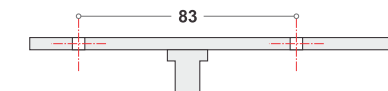

APF-10

Top patch pivot
Finish : Satin
Material : Stainless steel 304 grade

At **HART**, we constantly endeavor to raise the bar for excellence – be it in our designs, manufacturing or consumer relationship. We are grateful to have you as our valued client, associate and well-wisher and in order to meet your expectations – or even surpass it – we urge you to share your views with us at your convenience, so that we can improve upon perfection. We reiterate our commitment to deliver the most versatile range of architectural hardware fittings that translate your dream into a magical reality.



Mfg. & Mktd by

ALFA Industries

Rajkot (Gujarat)

🌐 www.alfahardware.com

✉ info@alfahardware.com